



MOULDED CABINET BI-DIRECTIONAL LOUDSPEAKER

APC6BT/EN



This on both sides sound expansion cabinet loudspeaker is a real innovation in design and performance. This exceptional loudspeaker is both stylish and elegant and offers a cost effective and robust alternative to the conventional wooden cabinet loudspeaker. Our standard finish is White, RAL9016. Designed to make installation quick and easy this makes it ideally suited for applications that require style as well as high performance such as shops, schools, restaurants, hotels, public houses, offices etc.



EN54-24:2008
0905-CPR-00280
TYPE A

● Standard	Compliant to EN54-24 Compliant to BS5839:8
● Electrical	
Rated power, Watts	6
Tappings 100 Volt line, Watts	6/3/1.5/0.75
Transformer Impedance, Ohms 100 Volt	1.67k/3.33k/6.66k/13.3k
Tappings 70.7 Volt line, Watts	3/1.5/0.75/0.375
Driver impedance, Ohms	4
Effective Frequency Range, Hz (BSEN60268-5)	110-18,000
S.P.L. @ 1 m, 1 Watt, dB, Octave, 100 Hz-10 kHz	95
S.P.L. @ 1 m, Full power, dB, Octave, 100 Hz-10 kHz	102
S.P.L. @ 4 m, 1 Watt, dB, 1/3 Octave, 100 Hz-10 kHz	72
S.P.L. @ 4 m, Full power, dB, 1/3 Octave, 100 Hz-10 kHz	77
Dispersion at 1k/2k Hz, Degrees	260/298 Horizontal 287/253 Vertical
● Environmental	
IP-rating	44
Min/Max amb temp	-25°C to 70°C
Relative humidity	≤95%
● Mechanical	
Dimensions, WxHxD, mm	246x116x100
Net weight, kg	1.3
Colour (Unless Specified)	White, RAL9016
Material	UL-94V0 Plastic, UV resistant
Mounting	4 x screw fixings
Safety	Ceramic Block Thermal Fuse



ATEIS Europe B.V.
 Celsiusstraat 1, 2652 XN Lansingerland, Netherlands
 Phone +31 (0)10 208 86 90, www.ateis-europe.com, info@ateis-europe.com





PENTON

INSTALLATION GUIDE

APC6BT/EN

EN54-24:2008
0905-CPR-00280
TYPE A

With Transformer:

100V/70V line

	White wire plus tapping				Black
100V	0.75W	1.5W	3W	6W	COM
70V	0.375W	0.75W	1.5W	3W	COM
IMP.(Ω)	13.3K	6.66K	3.33K	1.67K	

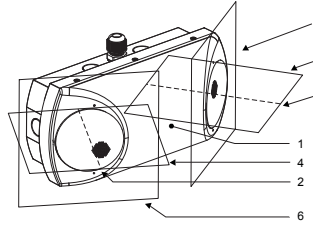
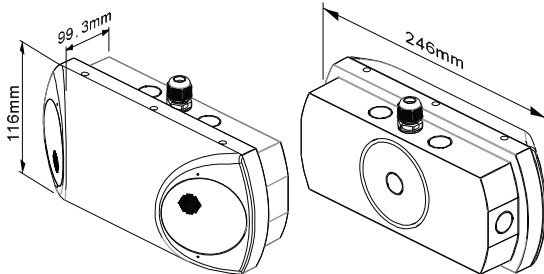

1. Loudspeaker enclosure
2. Reference axis 1
3. Reference axis 2
4. Horizontal plane 1
5. Horizontal plane 2
6. Reference plane 1
7. Reference plane 2

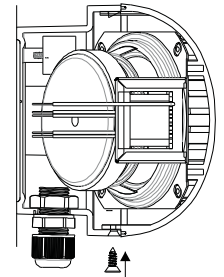
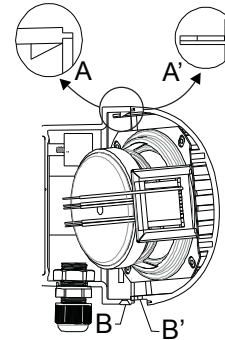
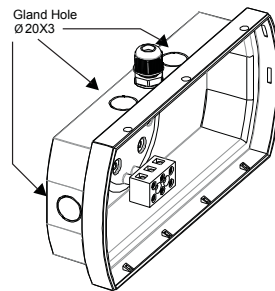
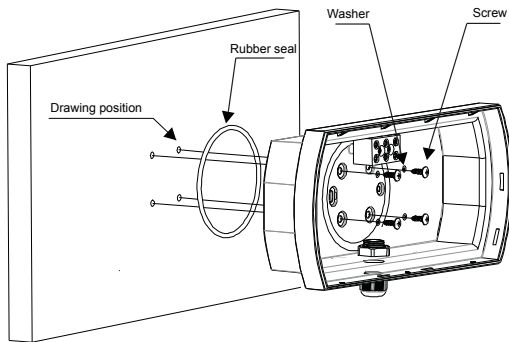

1) Select a suitable position to mount the loudspeaker. Offer the speaker to the wall or ceiling and mark through the mounting holes to position the fixing points to be drilled. Use a spirit level to ensure that the speaker will be level when fixed. Drill 4 fixing holes as shown in the diagram. Ensure you use the fixing holes that sit inside the rubber seal. The speaker can also be mounted to a standard single gang or BESA type back box. Use suitable raw plugs to secure the fixings.

2) Before fixing the speaker ensure it is correctly orientated to take the incoming speaker cable. The speaker can now be positioned over the fixing holes made in the mounting surface at Step 1. Ensure that the rubber "O" ring gasket is fitted as shown in Step 1 and then use suitable fixings to hold the speaker securely to the surface.

3) Terminate the speaker cabling into the terminal block via suitable cable glands. Select the correct tapping on the transformer located on the speaker front panel. Then fit the front panel to the back box taking note of the diagram right to ensure correct fitting.

4) Once the speaker front panel has been fitted to the back box secure in place using the supplied fixing screws as shown in the diagram right. The speaker installation is now complete.

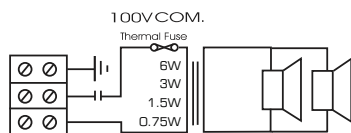

Circuit Diagram

Frequency response

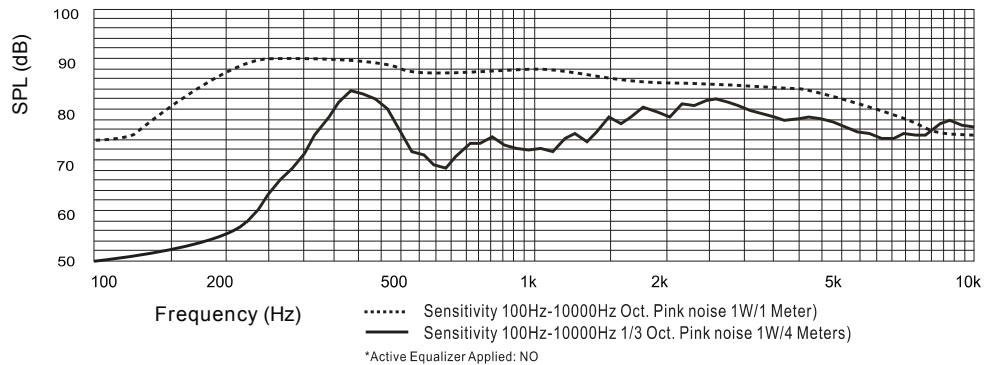

Disclaimer: We reserve the right of changes and errors.



ATEIS Europe B.V.
 Celsiusstraat 1, 2652 XN Lansingerland, Netherlands
 Phone +31 (0)10 208 86 90, www.ateis-europe.com, info@ateis-europe.com

